



Hot Water Generation – Steam/Water Single Wall

Digital-Flo® Steam/Water Shell and Tube Heat Exchanger

Model DF53540BS

DF53540BS is a complete pre-piped single wall instantaneous steam/water shell and tube heater. The assembly includes a properly sized shell and tube heat exchanger with a Digital Recirculating Valve (DRV40) and BrainScan® hot water monitoring control module.

Digital technology provides enhanced water temperature control accuracy and enhanced user safety in a single control component. BrainScan® technology to remotely view and adjust set point, data log and monitor inlet hot, inlet cold/return and mixed water outlet with multiple BAS interface options.

Operational Specifications

- +/-2°F water temperature control at points of use 25' downstream during demand
- +/-2°F water temperature control during zero system demand "idling" periods
- 2°F minimum valve inlet to outlet temperature requirement (system recirculation temperature loss)
- Automatic shutoff of hot water flow upon cold water inlet supply failure
- Automatic shutoff of hot water flow in the event of a power failure
- Programmable set point range of 81-158°F (27-70°C)
- Programmable 1st level hi/lo temp alarm display
- Programmable temperature error level for double safety shutdown.

Technical Specifications

- Maximum steam pressure: 15 PSIG
- Maximum domestic pressure: 150 PSI
- Minimum recirculation flow: 5 GPM
- Design conditions: Domestic-41 GPM at 100°F delta T using 15 PSIG steam
- Complete assembly Lead Free Compliant
- All domestic side valve fittings and isolation valves, strainers, inlet/return check valves, inlet system blend and return thermometers pre-piped.
- DRV – all wetted parts 316 stainless steel
- DRV to be UL Listed
- Heat exchanger tubes shall be straight 5/8" OD admiralty brass expanded into Navel Brass tube sheets with a free floating bolted end cover
- Water pipe of type L copper
- Fabricated carbon steel frame with machine grade enamel paint
- 120 volt power supply required
- Secondary (double) safety shut-off valve included

Connectivity

BrainScan® – Is an optionally selected control module from Armstrong which enables an interface with Building Automation Systems (BAS) which utilize Modbus, Bacnet™ or LonWorks™ protocols via the use of specific processor cards. BrainScan® also has an ethernet port and operates as a web server for remote network access.

BrainScan® has the following outputs:

- Set Point
- Inlet/Outlet Temperature
- Over Temperature Alert
- Error Messages

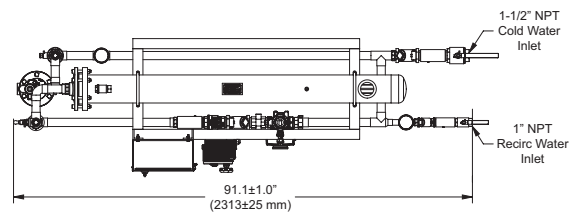
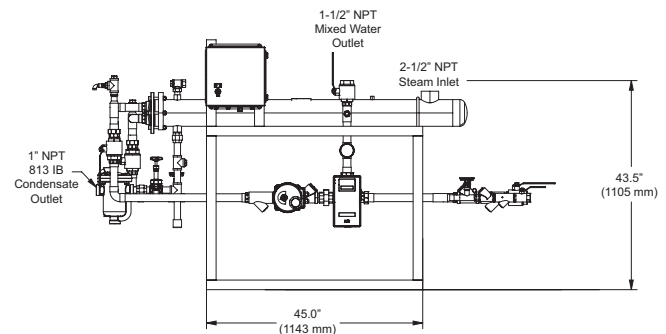
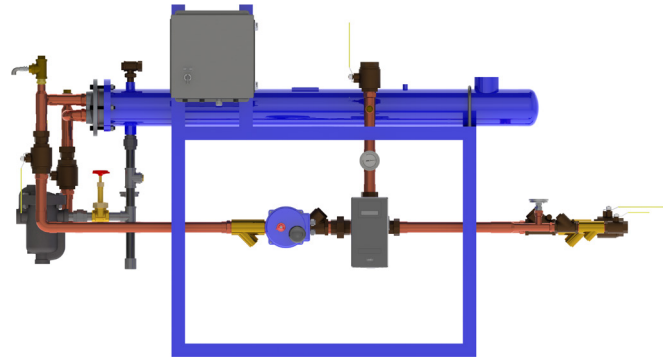

For a submittal drawing, refer to D589705.

Designs, materials, weights and performance ratings are approximate and subject to change without notice. Visit armstronginternational.com for up-to-date information.