

Differential Pressure Flow Sensors

V500 Single Support V510 Double Support Flanged Components

The Most Accurate and Reliable Technology for Measuring Gas, Liquid and Steam...

Developed from aerospace technology, the Verabar® averaging pitot flow sensor provides unsurpassed accuracy and reliability. With its solid, one-piece construction and bullet shape, the Verabar makes flow measurement leak proof and precise.

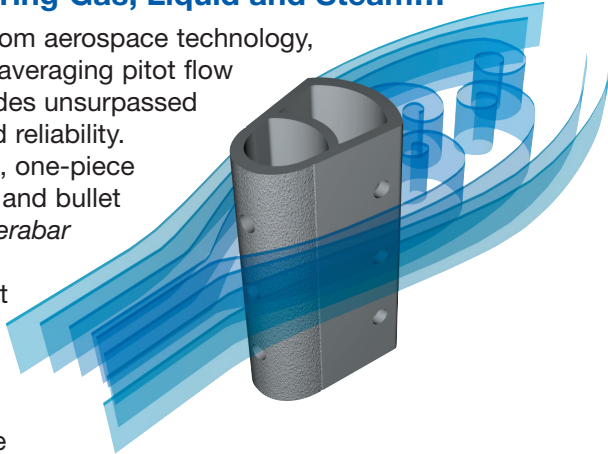

The unique sensor shape reduces drag and flow induced vibration. The location of the low-pressure ports eliminates the potential for clogging and improves signal stability.

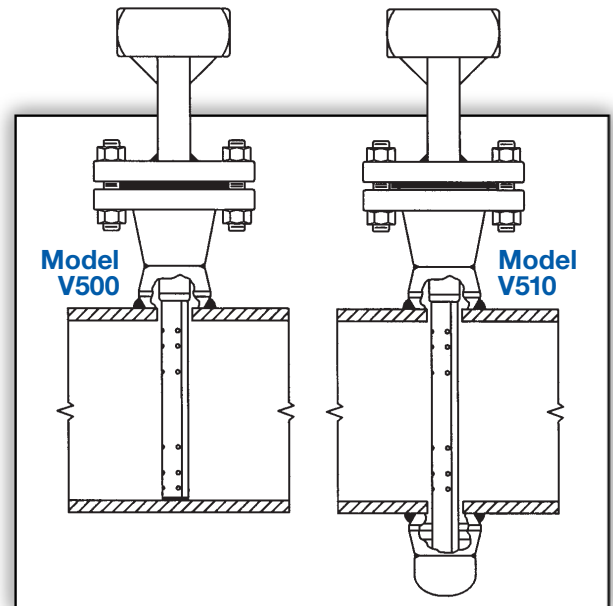

V500 Single Support V510 Double Support	
Pipe Connection	Flanged
Mounting Type	Flanged up to ANSI Class 2500#
Features and Benefits	<ul style="list-style-type: none"> All welded mounting Preferred mounting in power, petrochemical and refining industries Can mount to existing flanges
Applications	<ul style="list-style-type: none"> Air Natural gas Hydrocarbon liquids and gases Water (raw, cooling, feedwater) Hazardous fluids Steam Large pipes and ducts
Special Designs – Consult Factory	<ul style="list-style-type: none"> Custom mounting, lengths, materials, instrument connections, etc. Short straight run

Temperature Pressure Limits (ANSI Class)*
150#
275 psig @ 100°F (19 Bars @ 38°C)
80 psig @ 800°F (5.5 Bars @ 426°C)
300#
720 psig @ 100°F (49.6 Bars @ 38°C)
410 psig @ 800°F (28.3 Bars @ 426°C)
600#
1440 psig @ 100°F (99.3 Bars @ 38°C)
825 psig @ 800°F (56.9 Bars @ 426°C)
1500#
3600 psig @ 100°F (248.2 Bars @ 38°C)
190 psig @ 1500°F (13.1 Bars @ 815°C)
2500#
6000 psig @ 100°F (413.7 Bars @ 38°C)
315 psig @ 1500°F (21.7 Bars @ 815°C)

Model Specifications	V500 and V510		
Sensor Code	05	10	15
Sensor Diameter	7/16" (11mm)	7/8" (22mm)	1-3/8" (35mm)
Accuracy	±1% of flow rate; ±0.5% if calibrated		
ANSI Class*	150#, 300#, 600#, 1500# and 2500#		
Pipe Size	2"-6" (50mm-150mm)	6"-48" (150mm-1200mm)	12"-192" (300mm-5000mm)
Instrument Connection	1/2" NPT or Socket Weld	1/2" NPT, Socket Weld or Direct Mount	
Components Furnished	Weld coupling, weldneck flange, gasket, studs & nuts V510 includes additional weld coupling and pipe cap.		
Flange Size	1"	1-1/2"	2"

* DIN and JIS flanges available. Consult factory.

Verabar® Flanged Models

V500 (Single Support) V510 (Double Support)

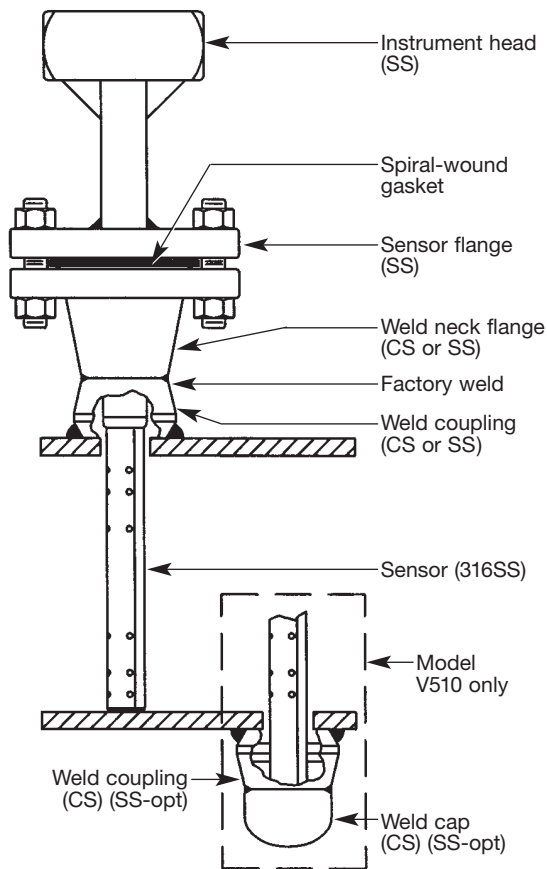

Furnish the following information:

1. Enter Pipe Dimensions or Duct Dimensions

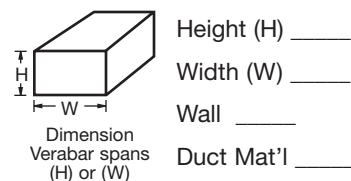
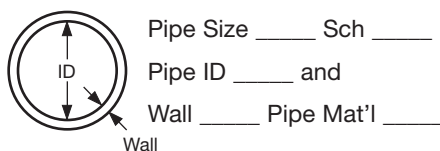

2. Pipe or Duct Orientation

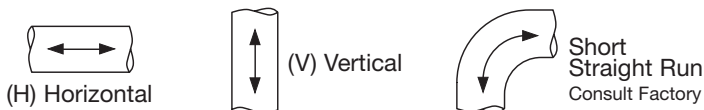

3. Enter Flow Conditions

Fluid Name:		Maximum	Normal	Minimum	Units
Flow Rate					
All Fluids	Temperature @ Flow				
	Pressure @ Flow				
Gas	Specific Gravity, or Molecular Weight				
Liquid	Specific Gravity				
Steam	Veracalc Program can calculate Density from Temperature and Pressure				

4. Select Model from Page 3

Use the Ordering Information table on Page 3 to determine your model number.

5. Flow Calculation



All Verabar applications require a flow calculation to verify the DP, pressure and temperature limits, structural limits and to size the transmitter. The Veracalc PC Program is for use by representatives and end users. It is easy to operate and **includes steam tables**.

Applications up to ANSI Class 2500#

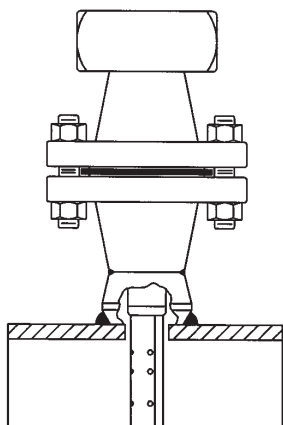

High Pressure and Temperature Head Option

Unique Design Features

High Pressure Threaded (HPT) and High Pressure Socket (HPS) designs offer the highest possible pressure and temperature capabilities. When pressure containment and safety are primary concerns, the HPT/HPS has the strongest and safest design in the industry.

As with all Veris designs, it meets ANSI/ASME B31.1 and can be supplied with code welding (ASME Section IX), hydrostatic testing, N.A.C.E. and material traceability.

Applications

Main Header Steam Lines















Used for high pressure and temperature applications such as main header steam lines.

For these applications, pipe mounting assemblies are available in chrome-moly material (ASTM A182 F11, F22 & F91).

Other Applications

- High pressure and temperature gasses and liquids
- Natural gas transmission lines
- Boiler feed water lines
- Oil well injection lines

Ordering Information

Model	Flanged						
V500	Single Support						
V510	Double Support						
Pipe Size and Schedule or Exact ID and Wall Thickness							
Code	Sensor Pipe Size Range						
05	2" to 6" (50mm to 150mm)						
10	6" to 48" (150mm to 1200mm)						
15	12" to 192" (300mm to 5000mm)						
Code	Pipe Orientation						
H	Horizontal						
V	Vertical						
Instrument Connections (Select Remote or Direct Mount) (Transmitter sold separately)							
 Remote Mount Transmitter (1/2" NPT)				 Direct Mount Transmitter (Flanged 450°F/232°C Max.)†			
Parallel	Regular	RTD*	Valve	Transmount	Mass Transmount*	Manifold	
		 Explsn. Proof	 Integral		 Integral RTD	 Integral	
P	R	D	T	F	G	E	
Instrument Valves (Opt.)			Manifolds (Optional)				
 Remote Mount			 Direct Mount				
Needle	Gate	3-Valve		5-Valve			
							
1/2" NPT	1/2" NPT	Soft Seat	Hard Seat	Soft Seat	Hard Seat		
C2NC (CS) C2NS (SS)	C2GC (CS) C2GS (SS)	F3SC (CS) F3SS (SS)	F3HC (CS) F3HS (SS)	F5SC (CS) F5SS (SS)	F5HC (CS) F5HS (SS)		
Mounting Assembly — Select Material & Rating (Includes SS sensor flange, WN flange, weld coupling, spiral-wound gaskets, studs & nuts)							
Sensor (Flange Size)			Mating Flange Material & ANSI Class				
05 (1")	10 (1-1/2")	15 (2")					
Code							
F415C F415S	F615C F615S	F815C F815S	CS	150#			
			SS	150#			
F430C F430S	F630C F630S	F830C F830S	CS	300#			
			SS	300#			
F460C F460S	F660C F660S	F860C F860S	CS	600#			
			SS	600#			
High Pressure Instrument Head (ANSI Class 1500# & 2500#)							
HPT	1/2" NPT						
HPS	Socket Weld						
High Pressure Mounting Assy (HPT & HPS Connections)							
Sensor (Flange Size)			Mating Flange Material & ANSI Class				
05 (1")	10 (1-1/2")	15 (2.5" or 3")					
Code							
F4150C F4150S F4150F11 F4150F22	F6150C F6150S F6150F11 F6150F22	F10150C F10150S F10150F11 F10150F22	CS	1500#			
			SS	1500#			
			F11	2500#			
			F22	2500#			
F4250C F4250S F4250F11 F4250F22	F6250C F6250S F6250F11 F6250F22	F12250C F12250S F12250F11 F12250F22	CS	2500#			
			SS	2500#			
			F11	2500#			
			F22	2500#			
Typical Model Number							
V500	8"sch40	10	H	R	C2NC	F615C	

* For high pressure (>500psig) or high temperature (>500°F), remote mount RTD in a thermowell is preferred.

† Assuming adequate heat dissipation for transmitter.

CODE	PARALLEL	REGULAR	RTD	VALVE	NEEDLE	GATE
1/2" NPT	1/2" NPT	X PROOF	INTEGRAL	1/2" NPT	1/2" NPT	1/2" NPT
EMOUNT						

CODE	TRANSMOUNT	MASS TRANSMOUNT	MANIFOLD
F	INT RTD	RMT RTD	INTEGRAL
DIRECT			

MANIFOLDS	
3-VALVES	5-VALVES
SOFT SEAT F3SC (GS) F3SS (SS)	SOFT SEAT F5SG (GS) F5SS (SS)
HARD SEAT F3HC (GS) F3HS (SS)	HARD SEAT F5HG (GS) F5HS (SS)

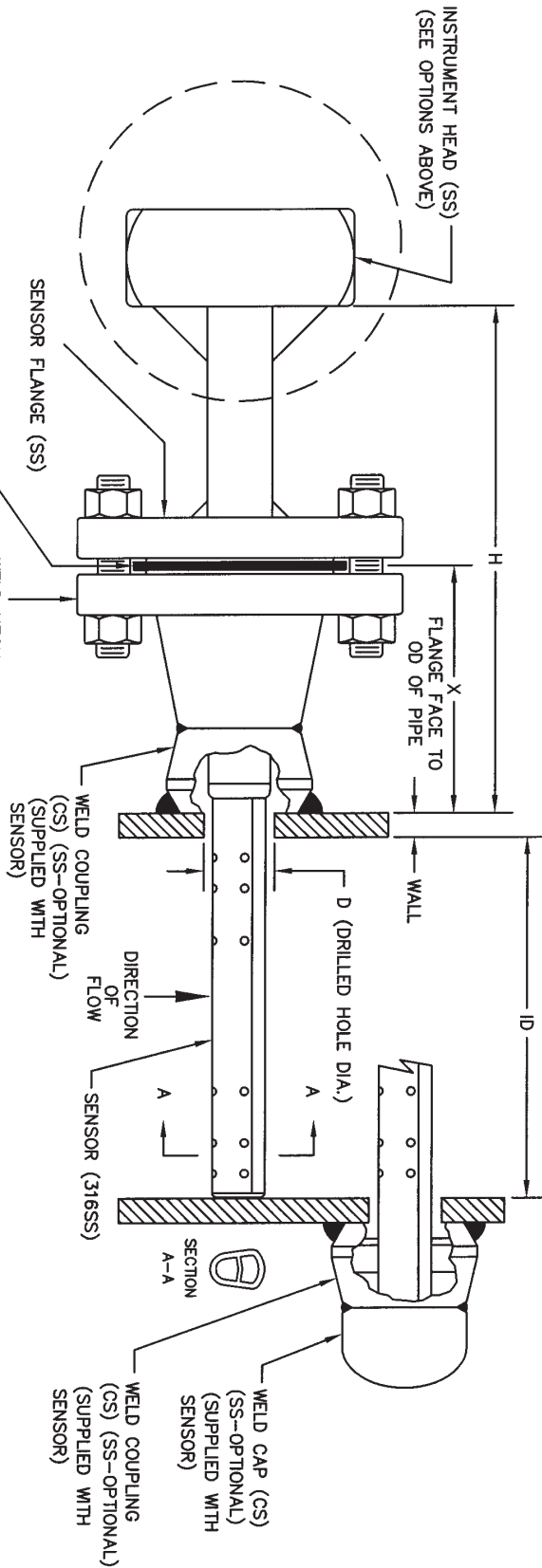

ITEM	SENSOR -05	SENSOR -10	SENSOR -15
SENSOR DIA.	1/2" (13mm)	7/8" (22mm)	1-3/8" (35mm)
FLANGE & COUPLING SIZE	1"	1-1/2"	2"
DIM D* DRILLED HOLE DIA.	1/2" (13mm)	1" (26mm)	1-1/2" (39mm)
DIM H** ANSI CLASS 150#	6.7" (170mm)	7.9" (200mm)	9.3" (235mm)
DIM H** ANSI CLASS 300#	7.3" (186mm)	8.4" (214mm)	9.8" (249mm)
DIM H** ANSI CLASS 600#	7.8" (198mm)	9.1" (230mm)	10.6" (268mm)
DIM X* ANSI CLASS 150#	3.31" (84mm)	3.81" (97mm)	4.06" (103mm)
DIM X* ANSI CLASS 300#	3.56" (90mm)	4.06" (103mm)	4.31" (110mm)
DIM X* ANSI CLASS 600#	3.81" (97mm)	4.38" (111mm)	4.69" (119mm)

*H & X DIMENSIONS ARE APPROXIMATE (FOR SIZING PURPOSES ONLY.)

NOTES:
1. CONTACT VERIS FOR DIMENSIONAL DRAWING FOR HIGH PRESSURE THREADED (HPT) & HIGH PRESSURE SOCKET (HPS)

CUSTOMER: _____
PROJECT: _____
ORDER NO: _____
TAG NO: _____
PIPE SIZE & SCHEDULE: _____
CATALOG NO: _____
SERIAL NO: _____
CERTIFIED BY: _____ DATE: _____

Veris, inc.
6315 MONARCH PARK PLACE
NIWOT, CO 80503
PHONE: 303-652-8550
FAX: 303-652-8552

VERABAR MODEL: V500/V510
FLANGED CONNECTION

DATE: 09/20/01
SCALE: NTS
REV: A
DWG NO: SUB-3941
PAGE: 1 OF 1